



### Specifications

Nominal Size	92 mm (3.50 in)	(See attached drawing)
Impedance	8 Ohm $\pm$ 15%	at 800 Hz 1 V
Resonant frequency	300 Hz $\pm$ 60 Hz	at 1 V
Sound pressure level	93 dB/w $\pm$ 3 dB	1 w 50 cm ave. at 0.5K, 0.7K, 0.9K, 1.0K Hz
Response	Fo Hz ~ 13 KHz max 10 dB	
Input power	Nominal 2 W	Handling capacity 3 W
Operation	must be normal at program source 2 W	
Buzz, rattle, etc.	must be normal at sine wave 4 V	
Magnet	Size: 39 x 22 x 7 mm	
Load test	White noise 2 W	for 5 hours
Heat test	70 $\pm$ 2° C	20-50% R.H. 5 hours
Humidity test	40 $\pm$ 2° C	90-95% R.H. 5 hours

### Frequency Response Curve

Potentiometer range	50 dB
Rectifier	RMS
Lower limit frequency	20 Hz
Wr. speed	100 mm/sec

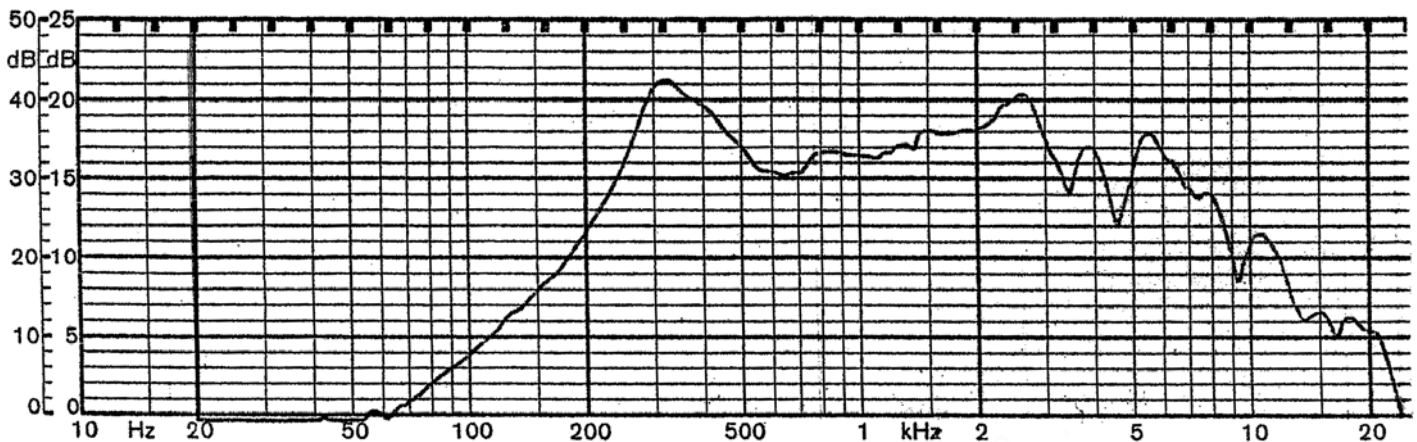

Zero level 60 dB

REV.	DESCRIPTION	DATE
A	NEW DRAWING	8/8/2006

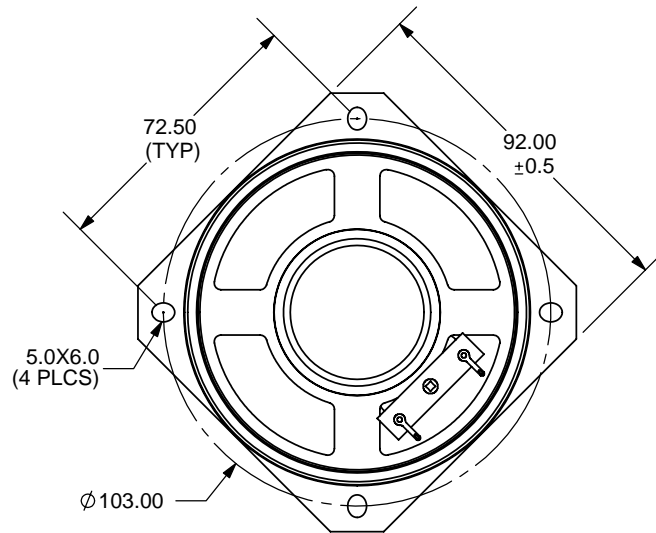
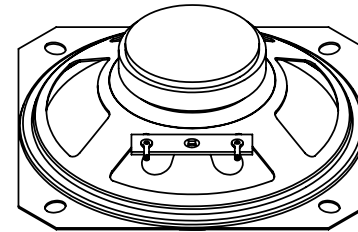
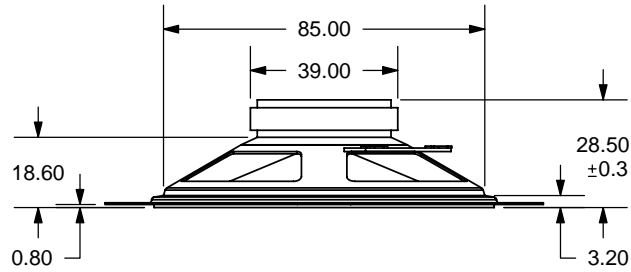

TOLERANCE:  
±0.5mm UNLESS OTHERWISE  
SPECIFIED



20050 SW 112th Ave.  
Tualatin, OR 97062  
Phone: 503-643-4899  
800-275-4899  
Fax: 503-372-1266  
Website: www.cui.com

TITLE: Square frame paper cone - ferrite magnet		REV: A
PART NO. GF0927	UNITS: MM [INCHES]	
DRAWN BY: ZRJ	APPROVED BY:	SCALE: 1:2

PC FILE NAME:  
GF0927

COPYRIGHT 2006 BY CUI INC.